

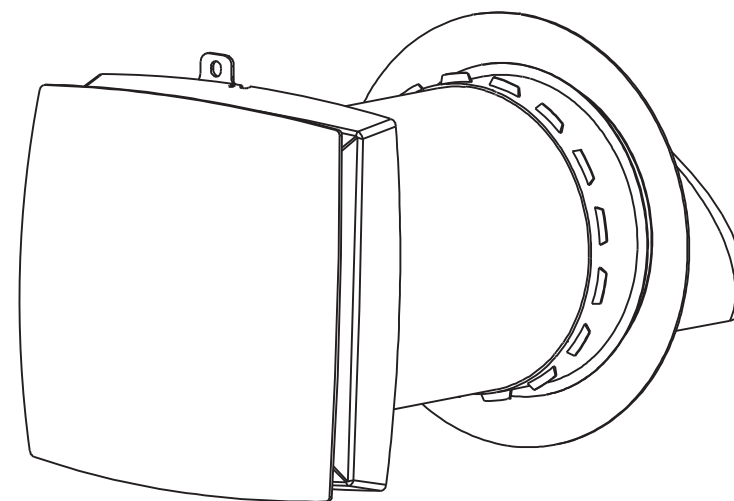

# F-ERV-A64-IW

Single Room  
Energy Recovery Ventilator  
Instruction Manual



CE

# Content

SAFETY REQUIREMENTS .....	3
INTRODUCTION .....	6
USE .....	6
PACKING LIST .....	6
MAIN TECHNICAL PARAMETERS .....	7
DESIGN AND OPERATION .....	9
INSTALLATION DRAWING .....	10
OPERATION MODES .....	11
VENTILATOR INSTALLATION .....	12
FUNCTION DESCRIPTION .....	14
REMOTE CONTROLLER .....	14
MASTER-SLAVE LINKAGE SYNCHRONIZATION FUNCTION .....	15
MASTER UNIT SETTINGS .....	16
SLAVE UNIT SETTINGS .....	17
MASTER AND SLAVE UNITS RESET AND CANCELLATION .....	18
IOT NETWORKING FEATURES .....	19
WIFI CONNECTION STEPS .....	20
MAINTENANCE .....	23
STORAGE AND TRANSPORTATION RULES .....	24
TROUBLESHOOTING .....	25

## SAFETY REQUIREMENTS

- Read the user's manual carefully before the operation and installation of the heat recovery ventilator F-ERV-A64-IW.
- Installation and operation of the ventilator shall be performed in accordance with the present user's manual as well as the provisions of all the applicable local and national construction, electrical and technical codes and standards.
- The warnings contained in the present user's manual must be considered seriously since they contain vital personal safety information.
- Failure to follow the safety regulations may result in an injury or ventilator damage.
- Read the manual carefully and keep it as long as you use the ventilator.
- This appliance can be used by children aged from 8 years and above and persons with reduced physical, sensory or mental capabilities or lack of experience and knowledge if they have been given supervision or instruction concerning the use of the appliance in a safe way and understand the hazards involved.
- Children shall not play with the appliance.
- Cleaning and user maintenance shall not be made by children without supervision.
- If the power supply cord is damaged, it must be replaced by the manufacturer or its service agent or similarly qualified persons in order to avoid a hazard.
- The ventilator is suggested to be installed more than 2.1 m above the floor.
- The precautions must be taken to avoid the back-flow of gases into the room from the open flue of gas or other fuel-burning appliances.
- Exhaust fans may adversely affect the safe operation of appliances burning gas or other fuels (including those in other rooms) due to backflow of combustion gases. These gases can potentially result in carbon monoxide

## Symbol Used In The Manual



**WARNING!**



**DO NOT!**

## Ventilator Installation Safety Precautions



The ventilator must be disconnected from the power supply prior to the installation or repair operation.



The ventilator must not be operated outside the temperature range stated in the user's manual or in aggressive or explosive environment.

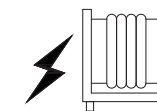

Do not position any heating devices or other equipment in close proximity to the ventilator power cord.

poisoning. After installation of an exhaust fan such as a partition fan or a duct fan the operation of open flue gas appliances should be tested by a competent person to ensure that backflow of combustion gases does not occur.

- Non-rechargeable batteries are not to be recharged.
- Batteries are to be inserted with the correct polarity.
- Exhausted batteries are to be removed from the appliance and safely disposed of.
- If the appliance is to be stored unused for a long period, the batteries should be removed.
- The power supply terminals are not to be short-circuited.
- Take good care of the remote control to prevent children from swallowing batteries and causing accidents.

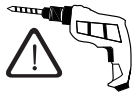
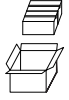
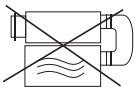
	Do not use damaged equipment or conductors to connect the ventilator to power.
	While installing the ventilator, follow the safety regulations specific to the use of electric tools.
	Unpack the ventilator with care.
	Use the ventilator only as intended by the manufacturer.

## Ventilator Installation Safety Precautions

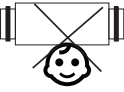
	Do not touch the controller or the remote control with wet hands. Do not carry out the ventilator maintenance with wet hands.
	Do not let children operate the ventilator.

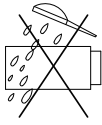
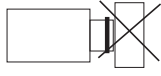
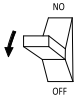
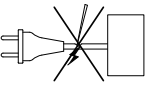
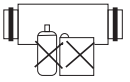
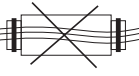
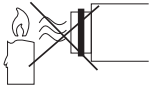
	Do not wash the ventilator with water. Protect the ventilator electric parts from water ingress.
	Do not block the air duct when the ventilator is on.
	Disconnect the ventilator from the power supply before maintenance.
	Do not damage the power cable while operating the ventilator. Do not put any objects on the power cable.
	Keep explosive and inflammable products away from the ventilator.
	Do not open the operating ventilator.
	Do not let air flow from the ventilator be directed to the open flame devices or candles.

## INTRODUCTION

This user's manual includes technical description operation, installation and mounting guidelines, technical data for the heat recovery ventilator F-ERV-A64-IW.

## USE

- The ventilator is designed to exchange air in apartments, villas, hotels, cafes, and other domestic and public buildings. The ventilator is equipped with a ceramic energy regenerator and a fan that supply of fresh air and extract air with energy recovery.
- The ventilator is designed for through-the-wall mounting. The telescopic ventilator design enables its installation in the walls from 230 mm to 420mm thickness.
- The ventilator is rated for continuous operation always connected to power mains.
- Transported air must not contain any flammable or explosive mixtures, evaporation of chemicals, coarse dust, soot and oil particles, sticky substances, fibrous materials, pathogens, or any other harmful substances.



**Installation And Connection Operations Must Be Performed Only By Properly Qualified Personnel After The Appropriate Safety Briefing.**

**The Ventilator Installation Sites Must Prevent Access By Unattended Children.**

## PACKING LIST

Ventilator	1
Accessories bag	1
Remote controller	1
User's manual	1
Packing box	1

## MAIN TECHNICAL PARAMETERS

- The ventilator is designed for indoor application with the ambient temperature ranging from -20°C (-4F) to +50°C (+122F) and relative humidity below 80%.
- The ventilator is classified as a class II electric appliance.
- Ingress Protection (IP) rating from solid objects and liquids IPX2.
- The ventilator design is regularly improved, so some models may be slightly different from those ones described in this manual.

## VENTILATOR OVERALL DIMENSIONS (mm)

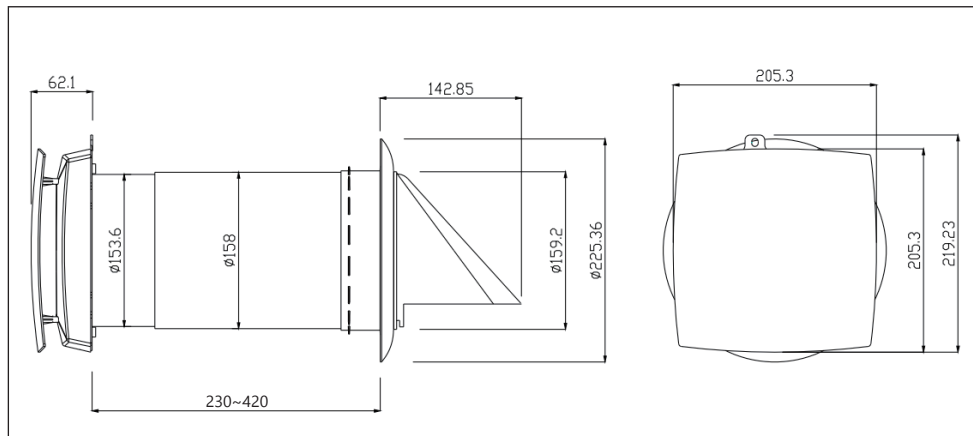

Voltage	100-240 V AC
Frequency	50/60 Hz
Input Power	5.9/8.8/11.3 W
Current	0.03/0.05/0.06 A
RPM	2000 (max)
Airflow (L/M/H)	26/55/64 m <sup>3</sup> /h
Sound Pressure Level at 1 Meter (dBA)	28/32.9/36.7 dB(A)
Sound Pressure Level at 3 Meters (dBA)	12/27.5/31.9 dB(A)
Regeneration Efficiency	up to 97%
Ingress Protection Rating	IPX2
Air Duct Diameter	159 mm
SEC	Class A
Mounting Type	Wall Mounting
Net Weight	3.4kg

## DESIGN AND OPERATION

- The ventilator consists of a telescopic air duct with adjustable length regulated by the position of the inner air duct inside the outer air duct, the ventilation unit, and the ventilation hood.
- Two filters and the ceramic energy regenerator are located inside the inner duct. The filters are designed to purify supply air and prevent foreign objects from ingress into the regenerator and the fan.
- The ceramic energy regenerator extracts energy from exhaust air to warm up or cool down supply air.
- The regenerator is equipped with a pull cord inside to facilitate its withdrawal from the ventilator. The regenerator is installed on an insulation material which is used as a sealant as well.
- The ventilator is available to be installed from the inner side of the wall.

## INSTALLATION DRAWING

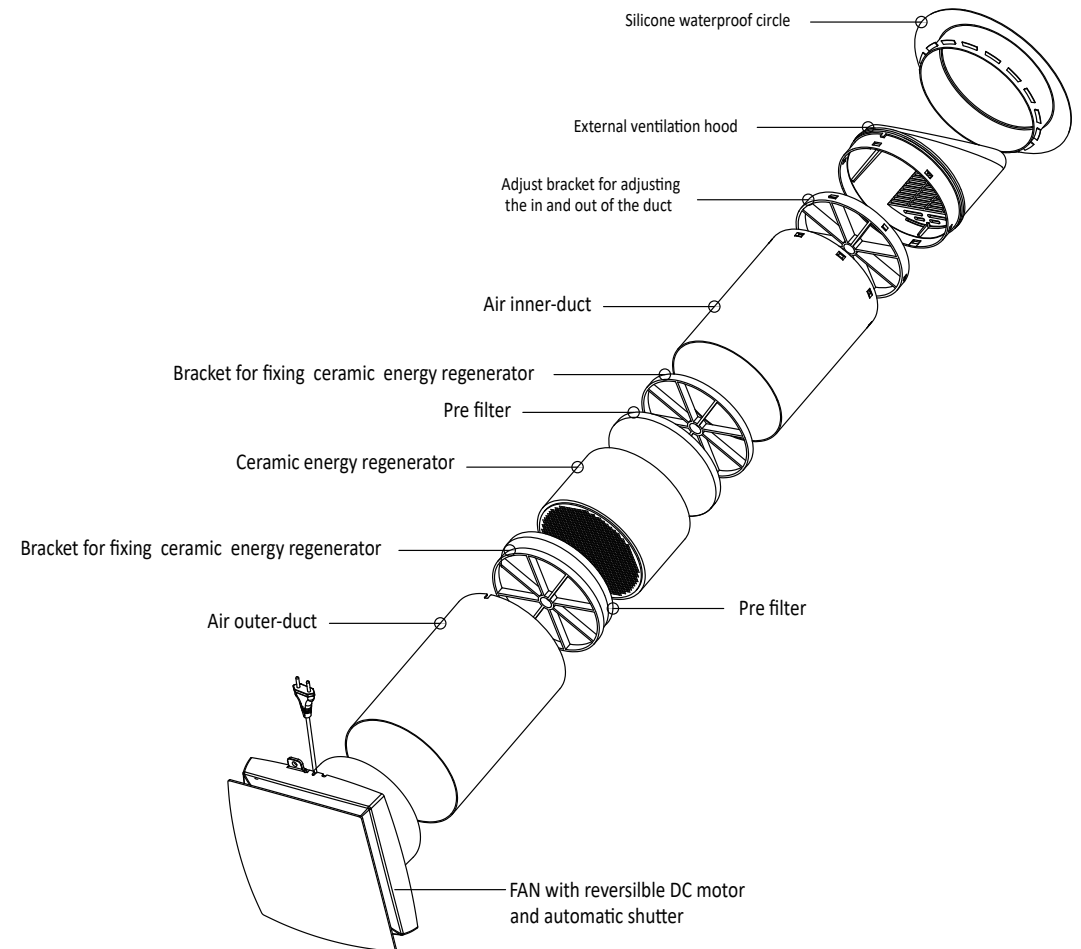

## OPERATION MODES

**Ventilation Mode.** The ventilator runs in the air extract or air supply mode with a set speed. In case of synchronous operation of two connected ventilators one unit operates in the supply mode and the other one in the extract mode.

**Regeneration Mode.** The ventilator runs in two cycles, 75 seconds each, to provide heat and moisture regeneration.

**Interval 1** The warm polluted air is extracted from the room and goes through the ceramic regenerator, which gradually absorbs heat and moisture. After 75 seconds the ventilator switch to supply air mode.

**Interval 2** The fresh and cold outdoor air goes through the heat regenerator and absorbs the accumulated moisture and heat after 75 seconds, when the energy regenerator gets cold, the ventilator switches to the air extract mode.

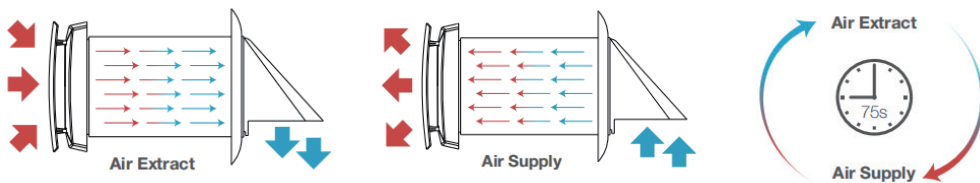

## INSTALLATION AND SET-UP



**CAUTION!**

### Read The User's Manual Before Installation The Ventilator

To prevent the room dust deposition and accumulation, the ventilator must not be installed in sites where the air duct may be clogged by the blinds, curtains, drapes, etc. Meanwhile, curtains might obstruct normal airflow in the room, thus rendering ventilator operation not efficiently.

## VENTILATOR INSTALLATION

1. Prepare a round hole through the inner wall. The hole size is shown below.

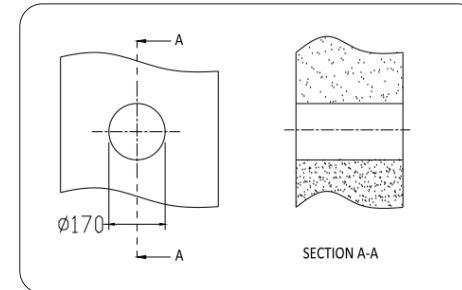

2. Assemble the inner duct and outer duct together to adapt to the thickness of the wall. Then take out the inner duct. Handle the bracket to turn the outer duct forward and backward, left and right to make the air inlet/outlet installed downward correctly by the sign of the external ventilation hood.

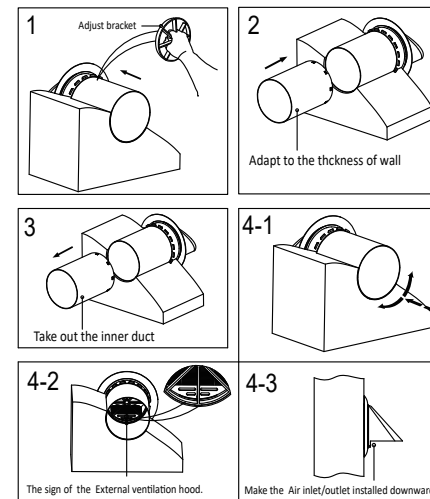

3. Install the ventilator through the wall hole from indoor, and pull back the duct by the adjust bracket to make the inner side rubber ring cling to the outside wall. Then put the inner duct in the hole and assembly inner duct and outer duct together. Fill the gap between the wall and duct with PU foam (Using the waterproof sealing glue for the gap close to indoor to against rainwater). The inner duct should parallel with the indoor wall surface.

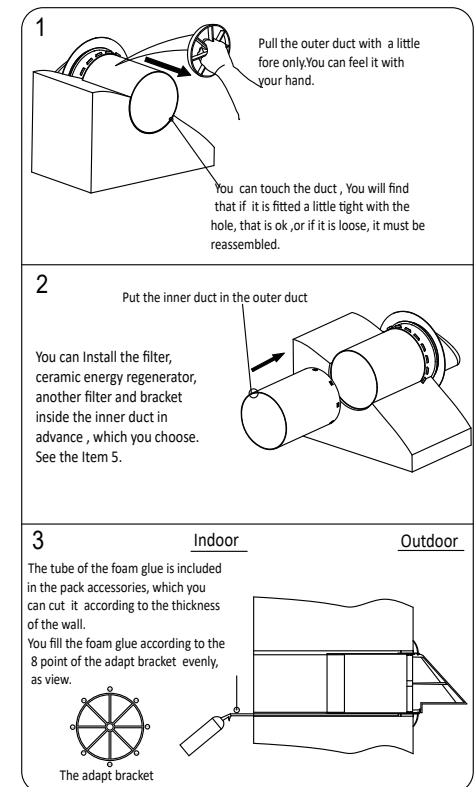

4. Fix the fan and the bracket by the nut, put the fan into the inner duct, mark the drilling hole site on the wall surface as the location, remove the fan, drill 1\*6mm hole on the marked place and put in the rubber plug (as pack accessories). Install the retaining bracket with a screw (as the pack accessories).

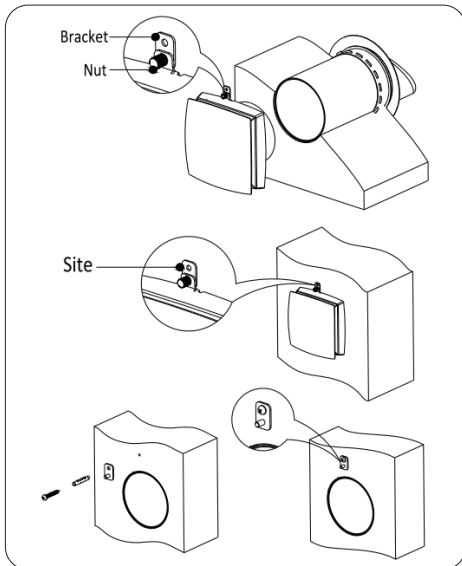

5. Install the filter, ceramic energy regenerator, another filter, and bracket inside the inner duct according to the correct sequence, before leaving the factory, all these parts are installed, so this part is mainly for the maintenance guidelines.

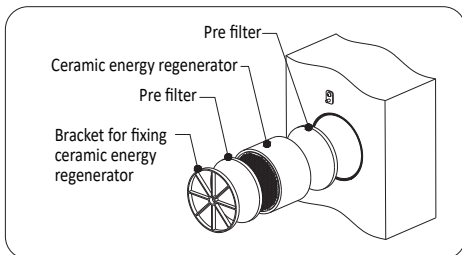

6. Install the fan on the wall surface. fix the fan to the bracket by the nut.

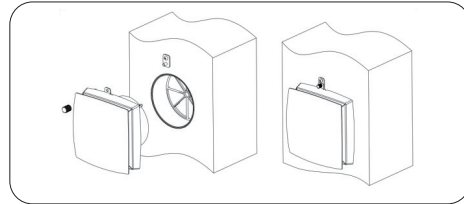

## FUNCTION DESCRIPTION

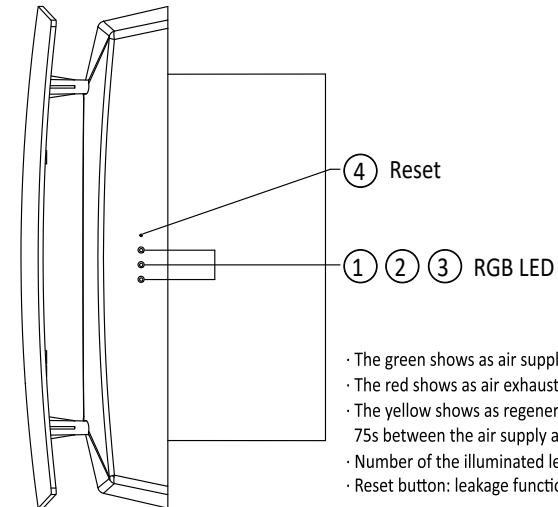

- The green shows as air supply.
- The red shows as air exhaust.
- The yellow shows as regeneration mode which is changed in 75s between the air supply and the air exhaust.
- Number of the illuminated led means the fan speed, 3 speeds in total.
- Reset button: leakage function.

## REMOTE CONTROLLER

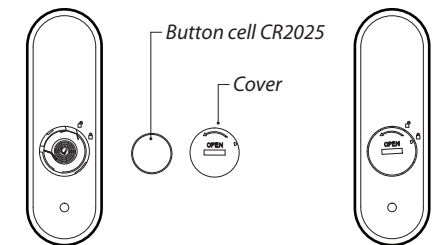
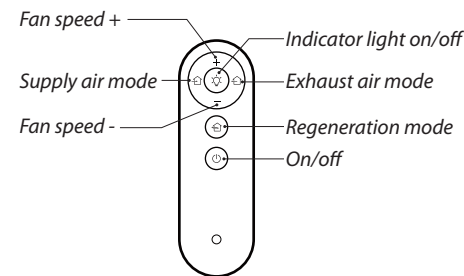

Please put in the button cell (prepared by user) before using the controller

- After putting in the battery, turn the battery cover clockwise as shown in the figure, until the triangular arrow on the cover indicates the locking pattern, that it's locked.
- To remove the battery, unscrew the battery cover counterclockwise as shown in the figure, until the triangular arrow on the cover indicates the unlock pattern, that it's released, and the battery can be taken out.
- Please take good care of the remote control to prevent children from swallowing batteries and causing accidents.



**CONNECTION TO POWER**

Disconnect the ventilation from power mains to any electric installation operations.

The ventilator is rated for connection to single-phase AC100-240 V/50-60 Hz power mains. Connect the ventilator to the socket directly.



## MASTER-SLAVE LINKAGE SYNCHRONIZATION FUNCTION

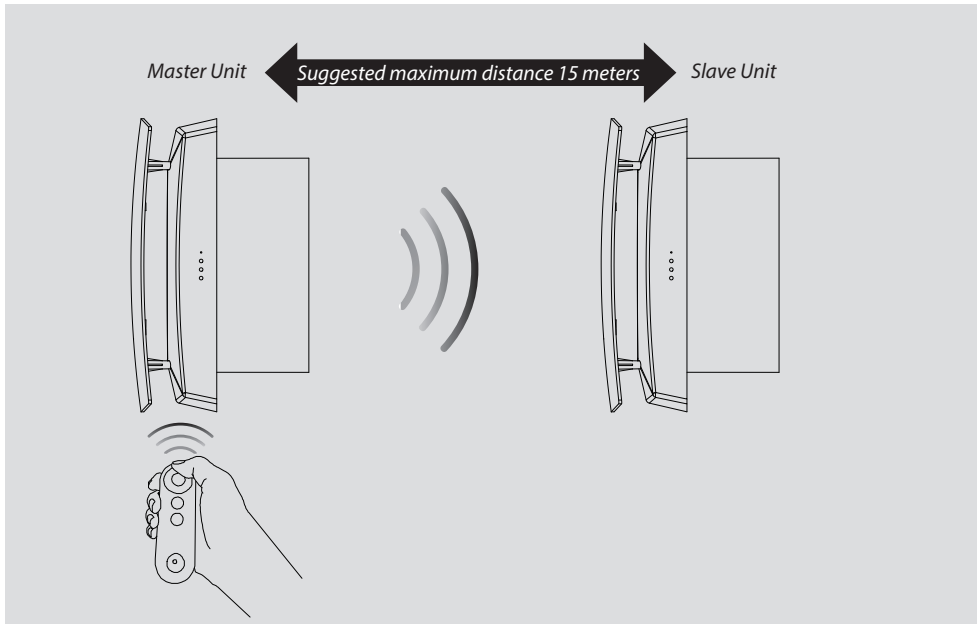

1. When the MASTER/SLAVE unit is not set, the remote controller can be used to control any machines independently.
  2. After the MASTER/SLAVE unit is set, the remote controller can only control the MASTER unit. And MASTER unit sends the signal to the SLAVE unit (the SLAVE unit doesn't receive the remote controller signal), so that the SLAVE unit runs the same mode as the MASTER unit. (One MASTER unit can be connected to multiple SLAVE units)
  3. In the regeneration mode, the fan running direction of the SLAVE unit is opposite to that of the MASTER unit, other states are consistent with the MASTER unit.
- » The maximum unobstructed communication signal distance between MASTER unit and SLAVE unit is around 15m.  
» The signal of MASTER unit and SLAVE unit can pass through the 180mm thick wall, but the transmission distance will be slightly reduced.

## MASTER UNIT SETTINGS

1. Feed power to the ventilator but in OFF state, use a needle to press the Reset button twice quickly (as shown in the figure). One green LED light will flash slowly, indicating that it enters a multiple linkage connection states.

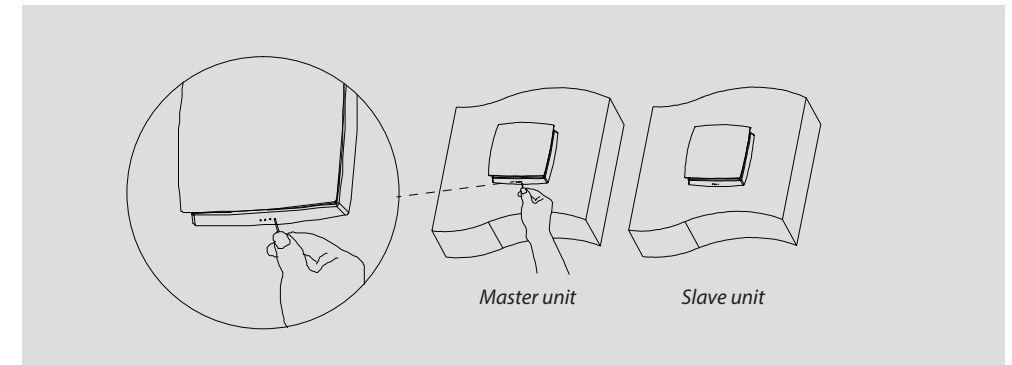

2. Direct the remote control to the machine and press the "+" button to set the machine to MASTER (as shown in the picture). One green LED light flashes five times and off, then the setting is completed. (Pay attention that after setting the MASTER unit, then this unit can only be controlled by the matching controller)

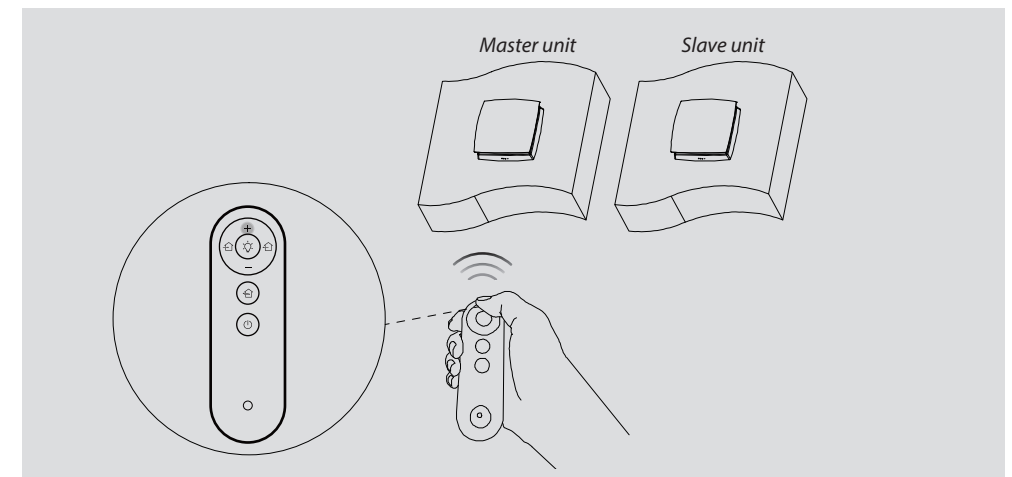

## SLAVE UNIT SETTINGS

1. The same steps as the MASTER setting. Feed power to the ventilator but in the OFF state, use a needle to press the Reset button twice quickly (as shown in the figure). One green LED light will flash slowly, indicating that it enters a multiple linkage connection states.

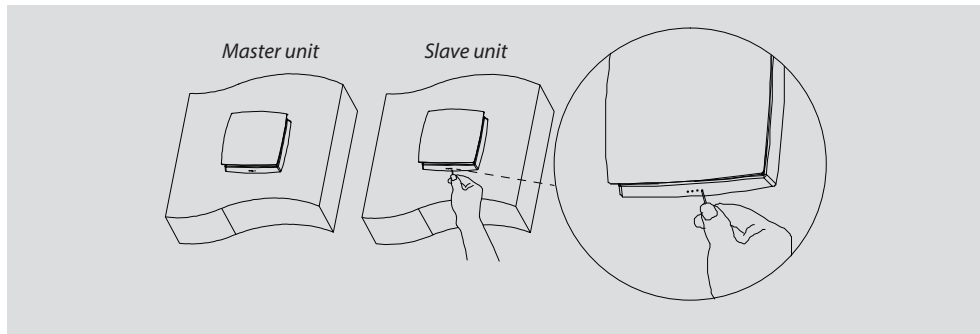

2. Use the remote controller (the same controller as its MASTER setting), towards the slave unit, and press "-" button to set the machine to SLAVE (as shown in the picture). One red LED light flashes five times and off, then the setting is completed. (multiple slave units can be set, except for the units which already been set as MASTER).

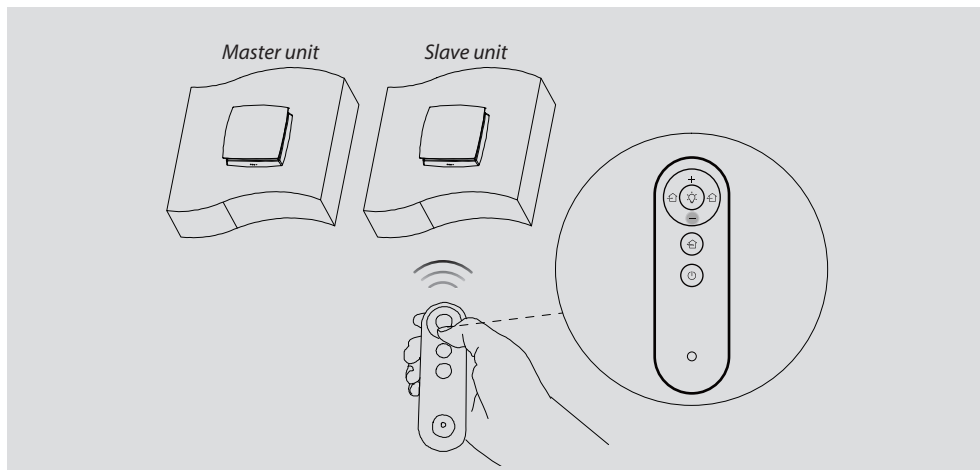

## MASTER AND SLAVE UNITS RESET AND CANCELLATION

Feed power to the ventilator but in OFF state, use a needle to press the Reset button over 10 seconds. Until all yellow LED lights flash 3 times, indicating that the MASTER or SLAVE setting to the ventilator is reset.

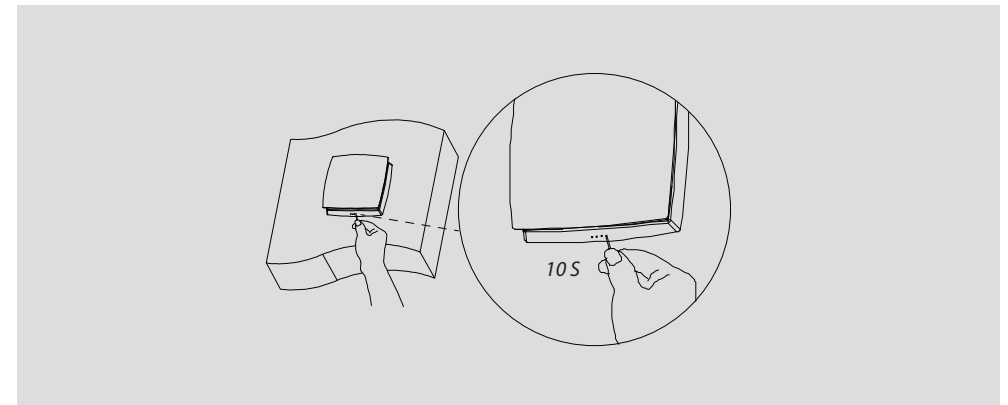

## IOT NETWORKING FEATURES

Scan the QR code and search "Smart Vent" from Google Play or App store to download the App.



or



Work with Alexa and Google Assistant

The connected ventilator is the MASTER one.  
*Any SLAVE ventilator is not able to be connected to the network. If a ventilator is connected to the network before the SLAVE setting, it will go offline once being set as the SLAVE. This linkage icon only displayed when MASTER and SLAVE linkage is set.*

The name of the connected ventilator. Multiple ventilators can be connected with different names.

Fan speed setting, 3 speeds in total.

Working mode (supply air mode, exhaust air mode, regeneration mode)

Illumination (LED lights) On/Off

Timer setting button  
 Set the timer on/off, under the setting period, can set the working mode and fan speed together.

On/Off button

## WIFI CONNECTION STEPS

1. Before linkage connection, please connect the mobile phone to the home wifi router (2.4G only), enable Bluetooth function, and ensure that the mobile phone can receive the wifi signal when put next to the ventilator.

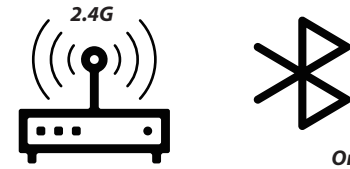

2. Feed power to the ventilator but in OFF state, use a needle to press the Reset button over 5 seconds, until all red LED lights flash, at this time, the ventilator is on the wifi connecting state (Red LEDs blink).

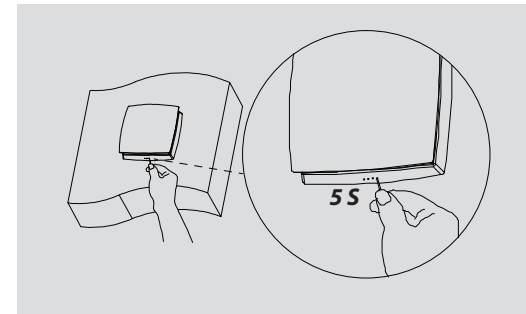

3. Open the mobile app, enter the operation page, click the add device, and search for the device.

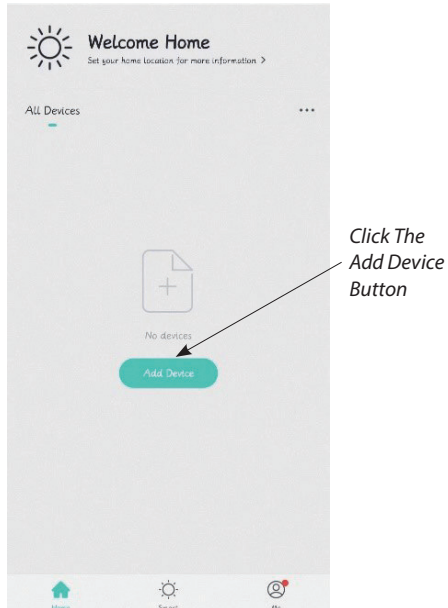

4. At this time, the app receives the signal from the ventilator. Click Add button to connect the machine to the network.



5. Find the same wifi signal as the mobile phone linked, make sure the wifi names are the same, and then enter the wifi password.

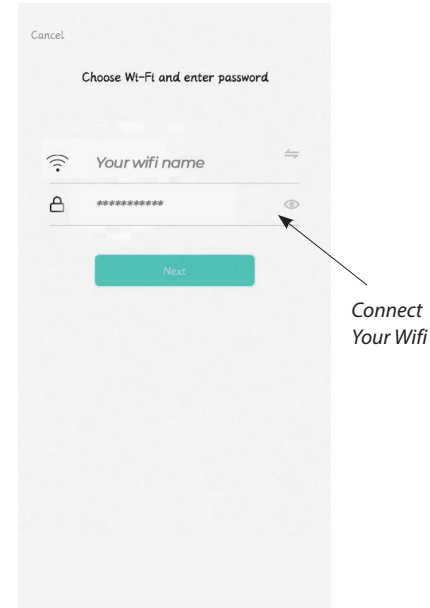

6. After the connection is completed, the user can enter the operation page to control the ventilator.

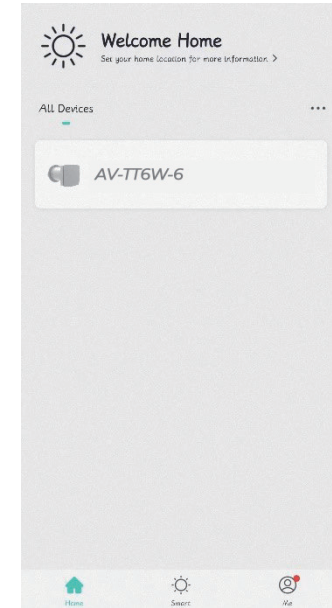

## MAINTENANCE



Disconnect The Ventilator From Power Supply Prior To Any Maintenance Operations.

Maintenance of the ventilator means regular cleaning of the ventilator surfaces of dust and cleaning or replacement of the filters.

### 1. Fan maintenance (once per year).

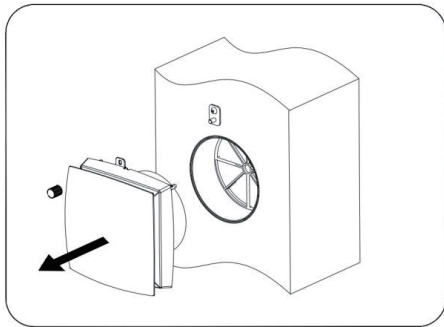

Loose the nut and pull the ventilator to remove.

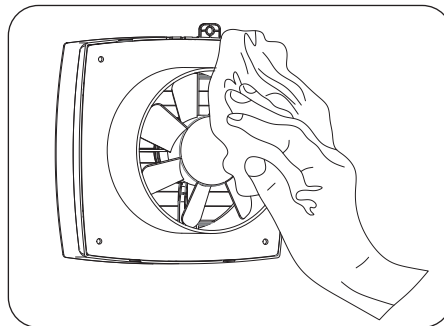

Clean the impeller blades. Use a soft brush, doth or a vacuum cleaner to clean the impeller. Do not use water abrasive detergents, solvents, or sharp objects. The impeller blades must be cleaned once in a year.

### 2. Regenerator and filter maintenance (4 times per year).

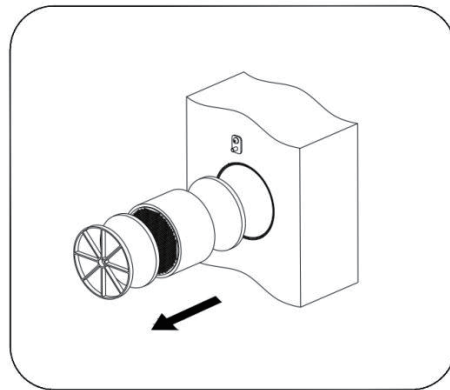

Remove the airflow rectifier and the filter in front of the regenerator.

Pull the regenerator cord to remove the heat exchanger from the air duct.

Be careful while pulling the exchanger to avoid damage.

Remove the filter after the regenerator.



Clean the filter as often as it gets dirty, but at least 3-4 times a year. Clean the filters, let them get dry, and install the dry filters inside the air duct. Vacuum cleaning is allowed. The filter rated service life is 3 years. Contact the Seller for spare filters.



Even regular technical maintenance may not completely prevent dirt accumulation on the regenerator assemblies. Subject the exchanger to regular cleaning to ensure high heat exchange efficiency. Clean the exchanger with a vacuum cleaner at least once a year.

## STORAGE AND TRANSPORTATION RULES

Store the ventilator in the manufacturer's original packing box in a dry place.

The storage environment must not contain aggressive vapors and chemical mixtures provoking corrosion, insulation, and sealing deformation. Use hoist machinery for handling and storage operations to prevent ventilator damage in a consequence of failing or excessive oscillation. Fulfill the handling requirements applicable for the applicable freight type.

Transportation with any vehicle type is allowed provided that the ventilator is protected against mechanical and weather damage.

Avoid any mechanical shocks and strokes during handling operations.

## TROUBLESHOOTING

Fault	Possible reasons	Fault handling
The fan does not start up during the ventilator start-up.	No power supply.	Make sure that the ventilator is properly connected to the power and make any corrections, if necessary.
	The motor is jammed, or the impellers are clogged.	Turn the ventilator off. Troubleshoot the motor jam and the impeller dogging. Clean the blades. Restart the ventilator.
Low airflow.	Low setting fan speed.	Set higher speed.
	The filter, the fan, or the exchanger are dirty.	Clean or replace the filter, and clean the fan and the exchanger. For the exchanger and the filter maintenance, refer to page 14.
Noise, vibration.	The impeller is dirty.	Clean the impeller.
	Loose screw Connection of the ventilator casing or the ventilation hood.	Tighten the screws of the ventilator or the outer ventilation hood.
Master-Slave units connection failed.	Master-Slave units setting by a different controller.	According to the manual, use the same remote controller for the Master-Slave units settings.
	The ventilator is installed in where has a lot of metal surrounding/there are interference sources around.	Excessive metal structures and interference sources around will weaken the wireless signal, please remove these interference sources or change the installation location.
	The distance between Master and Slave units is too long/the wall between them is too thick.	Please change the installation location according to the distance indicated in the manual.
	Other	Please reset the Master-Slave setting (press and hold the RESET button for ten seconds), and set it again after a period of power off.
WiFi connection failed.	The mobile phone is connected to the WiFi 5G network.	Please switch to the 2.4G frequency/network to connect.
	Wrong connected to public WiFi (such as WiFi in shopping malls, hotels, etc. That need to be registered and logged in).	Please set up the WIFI router correctly.
	The router has not yet set an account and password.	
	The router is set to a higher security level.	
	Exceeded the limit of devices that can be connected to the router.	
	Bluetooth on the mobile phone is off.	Enable Bluetooth on the mobile phone to improve the success rate of networking.